



PlayStation

®

NTSC U/C

PlayStation®



SUPERCROSS CIRCUIT™

EVERYONE



CONTENT RATED BY
ESRB

SCUS-94453
94453

WARNING READ BEFORE USING YOUR PLAYSTATION® GAME CONSOLE.

A very small percentage of individuals may experience epileptic seizures when exposed to certain light patterns or flashing lights. Exposure to certain patterns or backgrounds on a television screen or while playing video games, including games played on the PlayStation game console, may induce an epileptic seizure in these individuals. Certain conditions may induce previously undetected epileptic symptoms even in persons who have no history of prior seizures or epilepsy. If you, or anyone in your family, has an epileptic condition, consult your physician prior to playing. If you experience any of the following while playing a video game — dizziness, altered vision, eye or muscle twitches, loss of awareness, disorientation, any involuntary movement, or convulsions — IMMEDIATELY discontinue use and consult your physician before resuming play.

WARNING TO OWNERS OF PROJECTION TELEVISIONS

Do not connect your PlayStation game console to a projection TV without first consulting the user manual for your projection TV, unless it is of the LCD type. Otherwise, it may permanently damage your TV screen.

USE OF UNOFFICIAL PRODUCT

The use of unofficial product or peripherals may damage your PlayStation game console and invalidate your console warranty.

HANDLING YOUR PLAYSTATION DISC

- This compact disc is intended for use only with the PlayStation game console.
- Do not bend it, crush it, or submerge it in liquids.
- Do not leave it in direct sunlight or near a radiator or other source of heat.
- Be sure to take an occasional rest break during extended play.
- Keep this compact disc clean. Always hold the disc by the edges and keep it in its protective case when not in use.
- Clean the disc with a lint-free, soft, dry cloth, wiping in straight lines from the outer edge. Never use solvents or abrasive cleaners.

SuperCross Circuit Tips and Hints

PlayStation® Hint Line

Hints for all games produced by 989 Studios are available:

Within the US: **1-900-933-SONY** **(1-900-933-7669)**

\$0.95/ min. auto hints, \$1.40/ min. live, \$6.95-\$16.95 for tips by mail (subject to availability) & \$5.00-\$20.00 for card recharge.

Within Canada: **1-900-451-5757**

\$1.50/ min. auto hints

For US callers, game counselors are available 8AM-5PM PST, Monday-Friday. Automated support is available 24 hours a day, 7 days a week.

In Canada, automated support is available 24 hours a day, 7 days a week.

This hint line supports games produced by 989 Studios. No hints will be given on our Consumer Service Line. Callers under 18 years of age, please obtain permission from a parent or guardian before calling. This service requires a touch-tone phone.

Consumer Service/Technical Support**1-800-345-SONY**

Call this number for help with technical support, installation or general questions regarding the PlayStation® game console and its peripherals. Representatives are available Monday-Friday, 7AM-6PM Pacific Standard Time.

989 Sports On-Line**www.989sports.com**

Our news is always hot! Visit our website and find out what's happening — new titles, new products and the latest information about 989 Sports.

Table of Contents

PLAYSTATION SETUP	2
CONTROLLER DIAGRAM	3
MEMORY CARD/SAVING DATA	3
GAME CONTROLS	4
ARCADE MODE	6
SINGLE RACE	6
TIME TRIAL	9
FREE RIDE	9
RECORDS	9
BONUS ITEMS	9
CAREER MODE	10
NEW RIDER/LOAD RIDER	10
2P SEASON	14
TRACK EDITOR	15
CREATE TRACK	15
OPTIONS	17
PLAYING THE GAME	18
GAME SCREEN	18
PAUSE MENU	22
SUPERCROSS CIRCUIT CREDITS	23

PlayStation Setup

Console

Top View

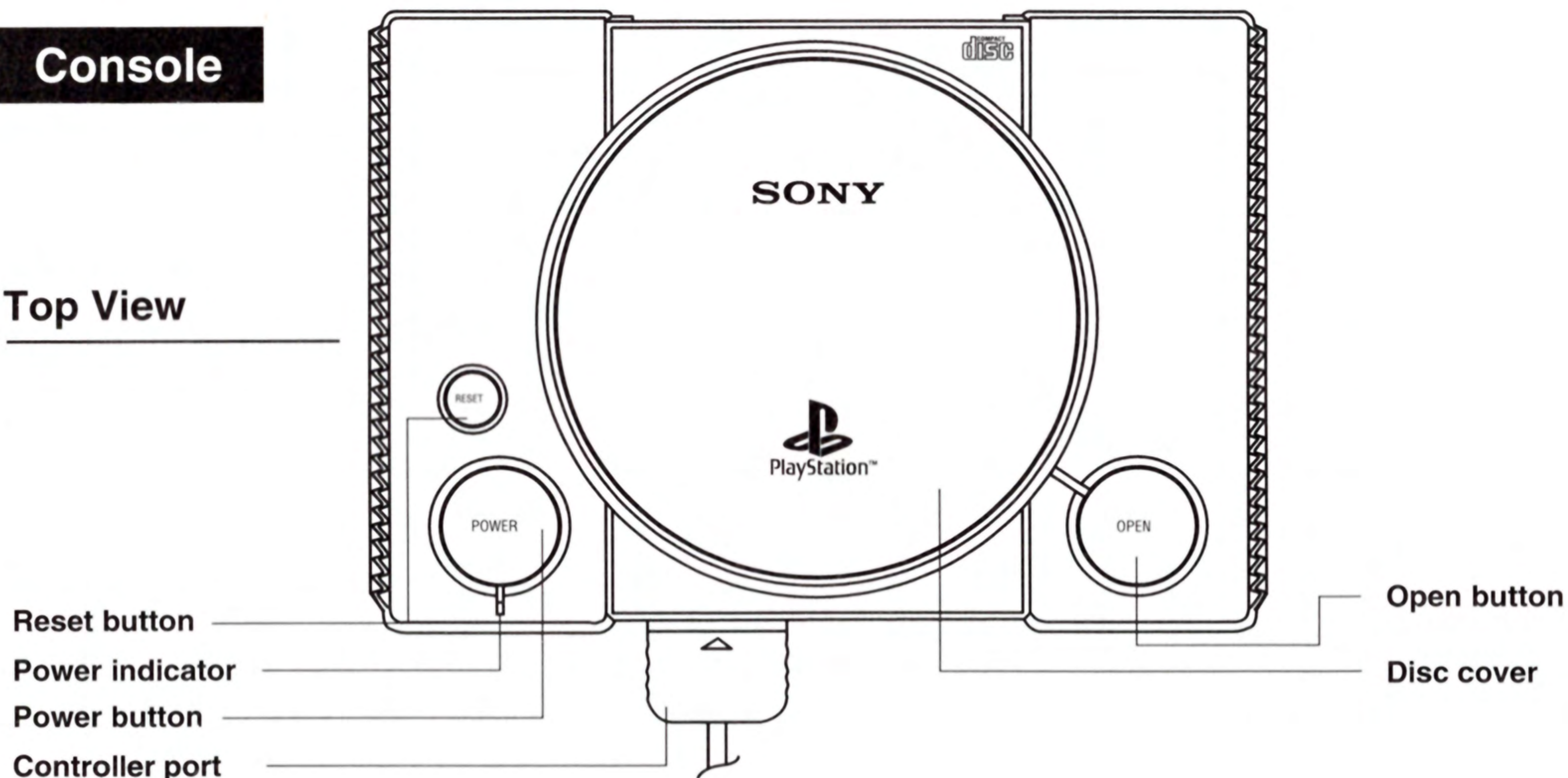

Front View

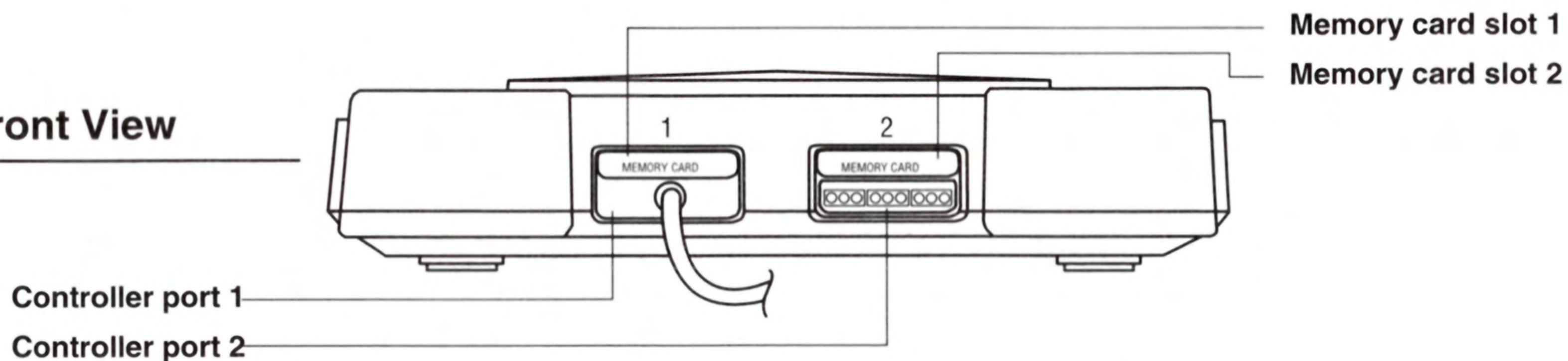

Set up your PlayStation® game console according to the instructions in its Instruction Manual. Make sure the power is off before inserting or removing a compact disc. Insert the SuperCross Circuit disc and close the disc cover. Insert game controllers and turn on the PlayStation® game console. Follow on-screen instructions to start a game.

Controller Diagram

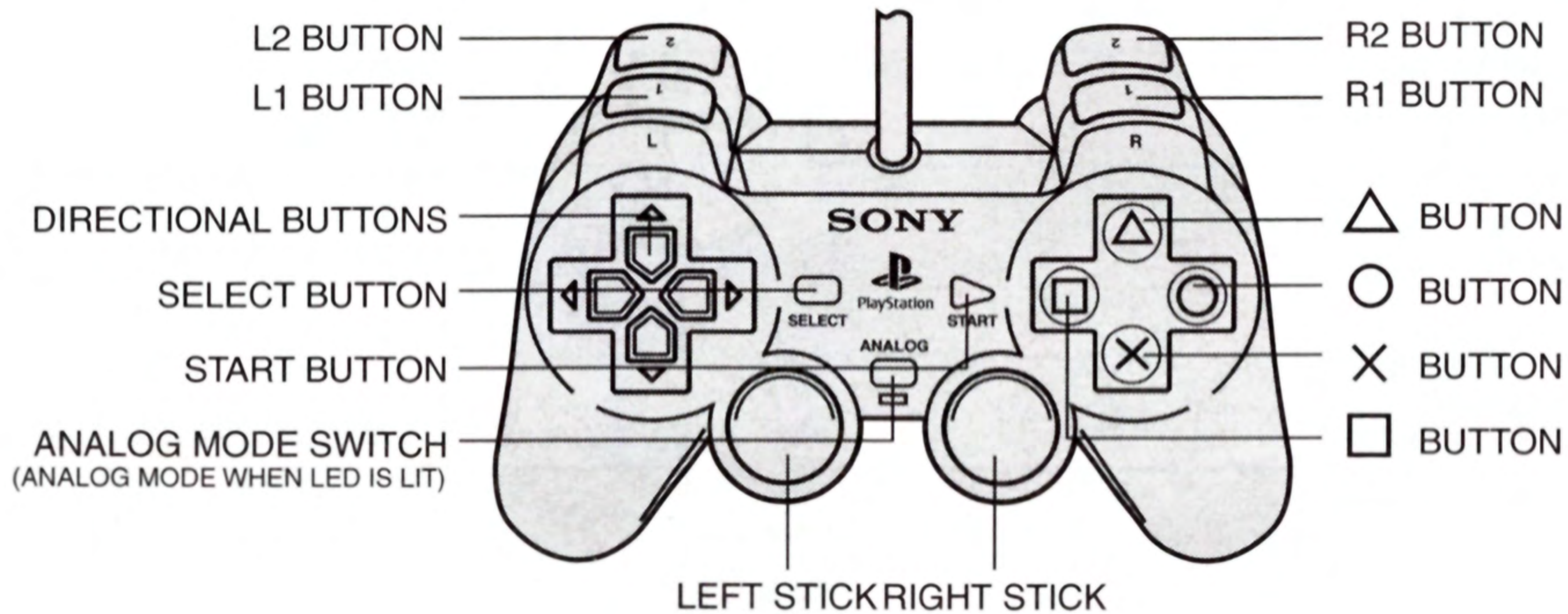

NOTE: Compatible only in Digital and Vibration mode.

MEMORY CARD/Saving Data

You must insert your MEMORY CARD before you save or load a file. SuperCross Circuit saves user-defined options and all data for a career, single race, time trial and free ride. One block of memory must be available on your MEMORY CARD in order to save game data. If you don't use a MEMORY CARD, all SuperCross Circuit data will be lost when you turn off your PlayStation game console.

Game Controls

GENERAL CONTROLS

Steer Rider Left/Right	D-Pad Left/Right
Lean Rider Forward/ Backward	D-Pad Up/Down
Break/Hard Steer	□
Look back	△
Throttle Burst	○/R1
Accelerate	⊗
Camera Select	SELECT
Pause	START

989 Sports' Tips:

To get a burst of speed going over jumps, while holding ⊗ roll your thumb to press and hold ○ at the same time.

For a better start, wait two to three seconds after the gate drops and then press ○ to use a throttle burst and race ahead of the pack.

TRICK CONTROLS

NAC-NAC	L2
CLIFFHANGER	R2
SURFER/SEAT STAND	L2 + R2
RECLINER	L2 + D-Pad Up
GYMNAST/PUMMEL BAR SPIN	L2 + D-Pad Down
CAN-CAN	L2 + D-Pad Left
CORDOVA	L2 + D-Pad Right
DOUBLE CAN-CAN/NO CAN	R2 + D-Pad Up
SEAT GRAB INDIAN AIR	R2 + D-Pad Down
NOTHING	R2 + D-Pad Left
RODEO HEEL CLICKER	R2 + D-Pad Right

989 Sports' Tips:

Tricks can be performed in succession. By pressing one trick control combination followed by another, your rider will perform two tricks in a row.

For more distance on a jump (in order to clear the triples), lean back by pressing Down on the D-Pad while on the face of the jump. Press  to throttle burst at the base of the jump.

Arcade Mode

Arcade mode allows you to race in a single race, time trial or free ride race.

SINGLE RACE

Use single races to learn how to play SuperCross Circuit. Get a feel for how the bikes perform on each of the tracks. See *Select Track* for more information about choosing a track. You can also play in a single race using a 2-player format without having to play a season.

PLAYER SETUP



To play a game involving more than one player, you need the appropriate equipment. In a 2-Player game, the player using controller 1 of the PlayStation is Player 1. When the game begins, Player 1 will be shown racing on the top portion of the screen. Player 2 will be shown racing on the bottom.

RIDER SKILL

Three different player levels give you the opportunity to race at your skill level. To prepare yourself for the challenge of racing at the Professional level, first master the Novice and Intermediate levels.

PLAYER 1/PLAYER 2

Choose a rider for your race from any of the 16 racers listed.

- D-Pad Up/Down to highlight a racer and press . To read a bio on a particular racer, highlight the racer's name and press .

SELECT TRACK

Select this option to choose a race track from the categories of Local Tracks, supercross or motocross. Local Tracks are simple to master and are a great way to learn the game. Supercross races are stadium events that consist of tighter tracks with bigger jumps and sharp turns. Motocross races are outdoor events with longer tracks and less jumps. After selecting a track category:

- D-Pad Up/Down to select a track location and press ⊗. Press ◻ to view track data.

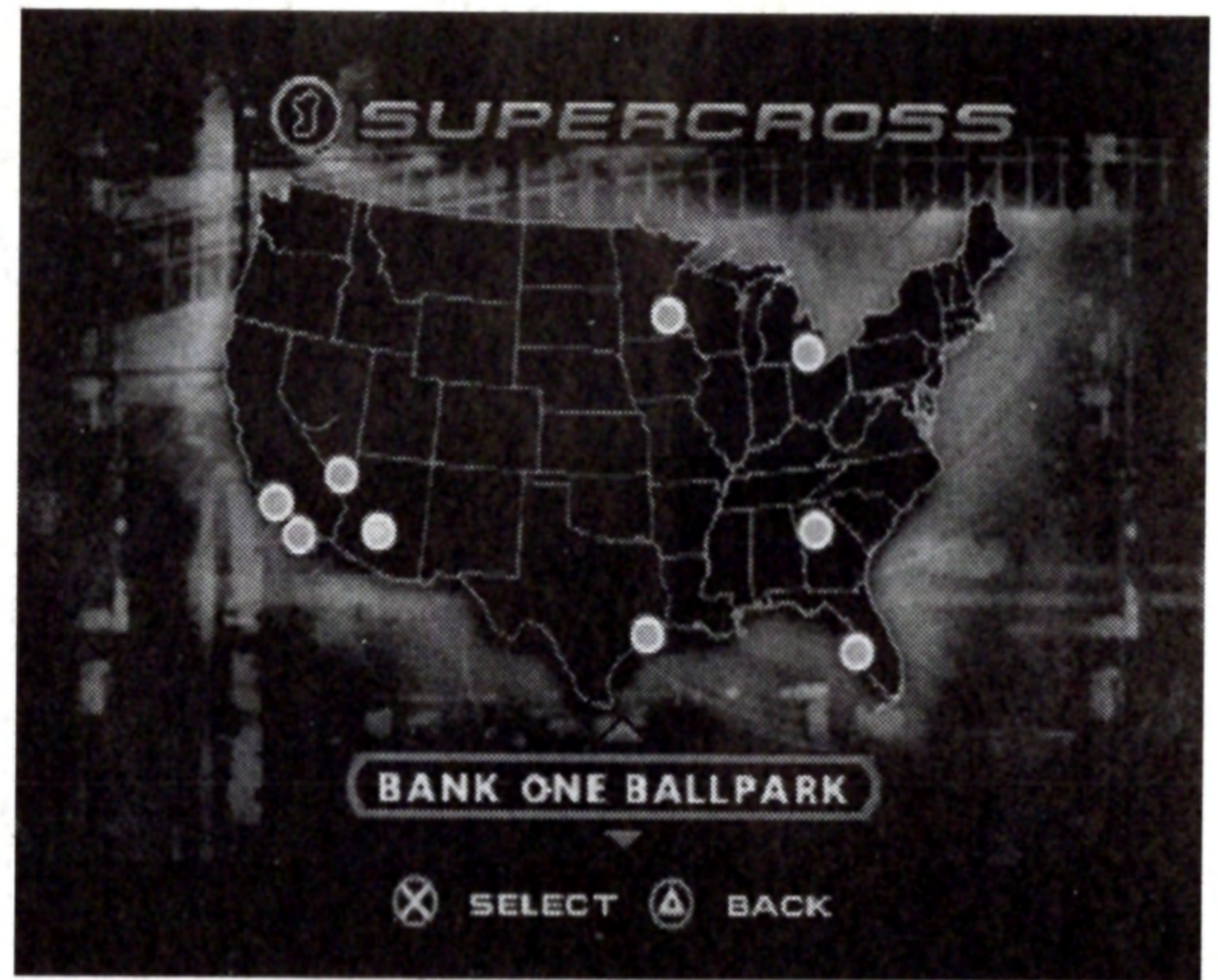

LAP COUNT

Choose the length of your race in lap counts of 5, 10 or 20.

RACE SETUP

This menu allows you to set the characteristics of your bike and race your selected track for your race.

989 Sports' Tip:

To short jump a Double, D-Pad Up while on the face of a jump. Remember to press ◎ to throttle burst at the base of the jump.

BIKE SETUP

Set up your bike to fit your racing style and the difficulty of the track you'll be racing.

SUSPENSION

A bike's suspension is its system of flexible members, such as springs of the bike intended to insulate it against road shocks. Stiff will give your bike a tight ride and your racer will feel the effects of the road more prominently. A Soft suspension will allow your bike to absorb more of the road's conditions. A medium suspension gives your bike a normal setting.

EXHAUST

A Torque exhaust system gives your bike a fast acceleration but has a slower top end speed. This type of system is best utilized on a track with short straightaways and many tight turns. A Midrange system is a balanced system of both Torque and Top End. A Top End system has a high rate of top end speed but doesn't have powerful acceleration. This system works best on tracks with longer stretches.

BRAKES

Setting up your brakes with a Front Bias will give your bike a front braking system that causes quicker stops and is more useful on tracks with less turns. A Neutral Bias is a basic braking system. Rear Bias will give your bike less brakes and allow your bike to increase sliding out around turns.

DONE

Done brings you back to the Race Setup screen.

RACE

Starts the race.

TIME TRIAL

A time trial race is a 1-player race with a main objective of beating the clock and getting the lowest time possible.

FREE RIDE

After winning enough career races, free ride will be unlocked. Free rides are trick competitions in which the object is to score as many points as possible by performing tricks in a certain time period.

RECORDS

View the time and point records established on each track.

- D-Pad Up/Down to cycle through each track.

BONUS ITEMS

Bonus Items are unlocked at the end of career stages. Once you've completed and won at the local level, cool bonus items will become available for you to use in the next career stage.

ENTER CODE

If you know a secret code capable of unlocking game items and options, press  and then spell out the code name.

989 Sports' Tip:

When entering a corner, press  while you are turning for a tighter turn.

Career Mode

Career mode allows you to race in a series of events. Careers consist of six race series on three different types of tracks; Local, supercross and motocross.



NEW RIDER/LOAD RIDER

Create a new rider for your career by selecting a name, purchasing a bike, and choosing rider gear. You can also load a previously saved rider from your MEMORY CARD. All loaded riders will be equipped with their latest bike and gear.

NOTE: Loading a rider will take you straight to the Career menu.

ENTER NAME

Enter the name of your new rider.

- D-Pad Left/Right to move spaces and Up/Down to select a letter or number. To delete a letter or number, highlight it and press .
- Press  to accept your rider's name.

BUY 125

This is where you purchase your rider's bike. At the start of a career, the only bikes available to you are the 125 models. 250CC bikes will be unlocked after you complete the 125CC season.

- Press  to view bike data.

CAREER

This menu allows you to save rider information, view player stats, further customize your rider's gear, buy a different bike and start your season.

QUIT

Quit will bring you back to the Main menu.

SAVE DATA

Save your rider data to your MEMORY CARD.

PLAYER STATS

View the career race stats and winnings accumulated by your racer.

RIDER GEAR

Choose your racer's clothing, color of his helmet and his boot type.

SPRAY BOOTH

Three sections of your racer's helmet can be painted.

- D-Pad Left/Right to choose a helmet then press ⊗.
- Press Left/Right and Up/Down to change colors.
- Press R1/R2 to raise/lower the brightness of the color.
- Press ⊗ to move to the next section.
- Repeat these steps to finish in the Spray Booth and press ⊗ from Done to go back to the Career menu.



CLOTHING

Pick the type and color of your rider's clothing.

- D-Pad Up/Down to select a clothing type and then Left/Right to choose a jersey color.
- Press ⊗ to accept your choice.

BOOTS

Pick the brand name of your rider's boots.

DONE

Done brings you back to the Career menu.

NEW BIKES

This is where you can purchase a different bike from the one your rider currently uses. Earn enough money from career wins to purchase a new bike.

START SEASON

Start a new career season.



989 Sports' Tip:

At times, in order to take the best line through a straightaway, you may have to "roll" over a jump to clear the rest.

SEASON MENU

Use this menu to make changes to your bike setup, run a practice race or start the season. See *Career* for descriptions of repeated menu items.

SEASON STATS

View each rider's season point totals and wins.

BIKE SETUP

Use this menu to buy bike parts, repair your engine or change your bike's attributes. Be sure to check the condition of your bike (located under its picture) to see if you need to make any upgrades or repairs before you spend your money. See *Bike Setup* under *Arcade Mode* for descriptions of repeated menu items.

BUY PARTS

As you finish career races, you will earn money that will allow you to buy bike parts and services.

ENGINE

You can purchase engine work for your bike by selecting a Top End rebuild or a Full Rebuild. As your career progresses, check the status of your engine and try to get away with Top Engine rebuilds to avoid having to spend a lot of cash for a Full Rebuild.



PRACTICE

Practice gets you out on the track as the only racer to work on your fundamentals and get a feel for the track.

START RACE

Start the season race.

2P Season

A 2-Player season not only allows you to play with another player, it allows you to set up to a 12-race season with the tracks of your choice. See *Career Mode* for more information on game screen setup.

AI ON/OFF

Keep AI ON to compete in a season race with other CPU riders.

TRACKS

Set up your 2-player season by picking the tracks for the each race.

- D-Pad Up/Down to choose a track.
- Press ⊗ to add the track to the season. Press ⊖ to remove a track that has been added.
- Repeat this process for up to 12 races.
- Press ○ to go to the 2P Season menu. See *Season Menu* for more information.

Track Editor

Track Editor gives you the opportunity to create a track, edit created tracks or load and save tracks to and from the MEMORY CARD.

CREATE TRACK

Using your controller, build a race track or free ride track. You can save 16 tracks to your MEMORY CARD.

NOTE: Race Tracks must have a Start and a Finish. Free ride tracks only need a Start.

- D-Pad Up/Down or Left/Right to choose a starting block for your track.
- Press R1/R2 to select the Start option from the list of road types and press ⊗ to paste your starting point.
- Continue to use the D-Pad to guide your track direction and R1/R2 to choose road types. To rotate the direction of a track block, press L1/L2. To copy and paste road types that have already been used, highlight a track block and press ◎ to copy. Paste it into a different track block by pressing ⊗. To delete road types, highlight the track block and press ◻.
- When your track is complete, press the START button to create your track.

989 Sports' Tip:

When exiting a corner, press ◎ for an extra burst on to the straightaway.

EDIT TRACK

Edit any of the tracks that you have created. See *Create Track* for details on how to change track attributes.

LOAD TRACK

Load a track from your MEMORY CARD.

- D-Pad Up/Down to choose a track and press ⊗.

SAVE TRACK

Save a track to your MEMORY CARD.

- D-Pad Up/Down to choose a track slot and press ⊗.
- Enter a track name by using the D-Pad Left/Right to choose a space and then Up/Down to select a number or letter. To include a space in your name, highlight a space and press ○. To delete a letter or number, highlight it and press □.
- Press ⊗ to accept the name.
- D-Pad to an empty MEMORY CARD block and press ⊗ to save the file.

RACE TRACK

Race the track that you have created. Selecting this option brings you through the race setup screens.

989 Sports' Tip:

After clearing a long jump (e.g., a triple), press ○ when you land to burst away from the pack.

Options

Options allows you to control the game attributes of your race.

AUDIO

Raise or lower the volume of the game sounds and music. You can also choose between Stereo or Mono sound.

- D-Pad Up/Down to choose an option and then Left/Right to pick a setting.

CONTROLLER 1/CONTROLLER 2

You can change the configuration of your regular controller to any of four settings. If you have a Dual Shock™ analog controller, you can change the configuration of its joysticks.

- D-Pad Left/Right to choose a configuration.

CAMERA VIEW

You can change the camera view to the distance that best suits you.

- D-Pad Left/Right to choose a camera setting.

CENTER SCREEN

Center the game screen on your television using the D-Pad.

LOAD/SAVE OPTIONS

Load or save game options to and from your MEMORY CARD.

Playing the Game

GAME SCREEN

The game screen consists of the current race conditions described below in clockwise fashion, starting in the upper left corner:

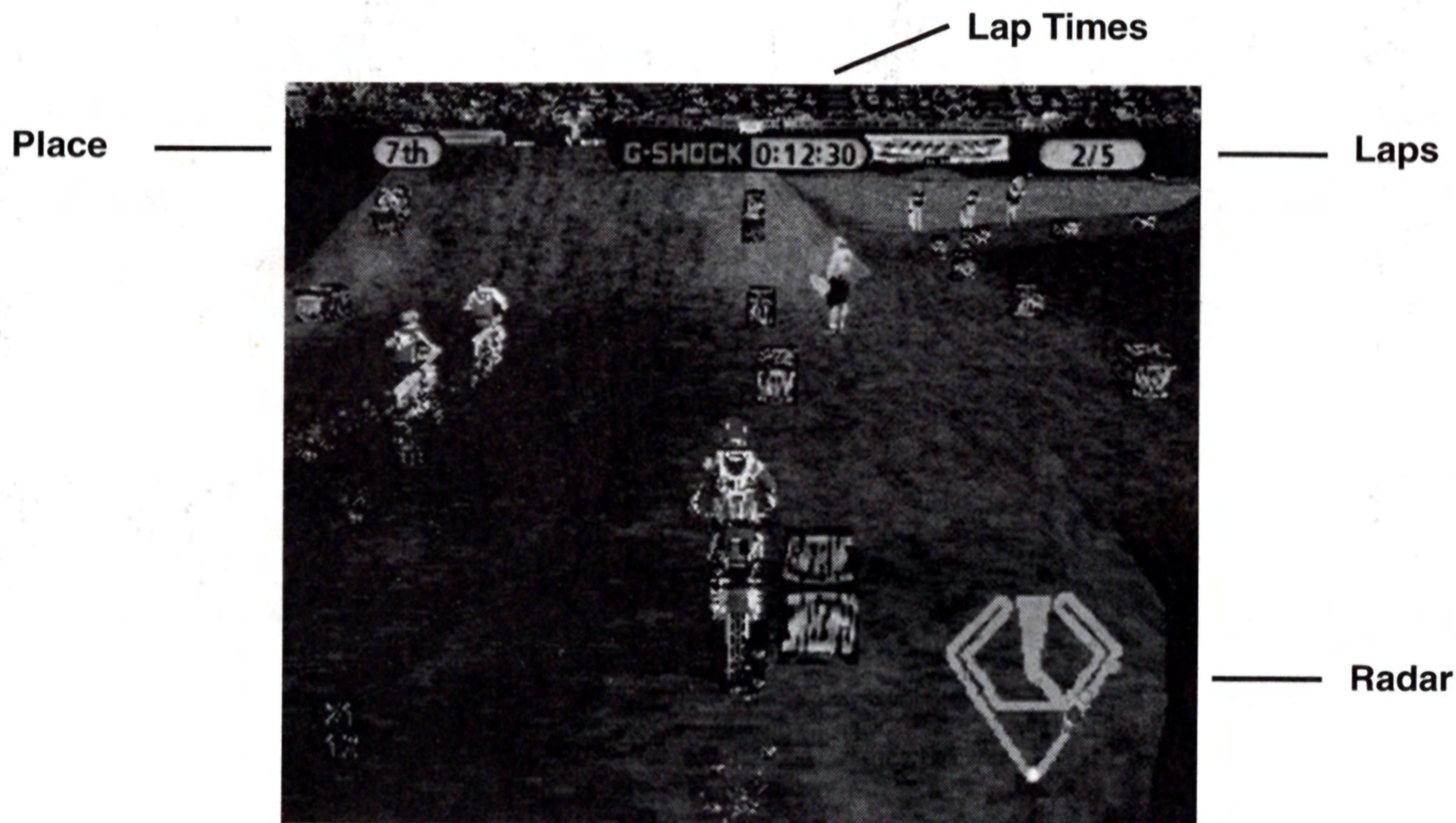

989 Sports' Tip:

Your throttle burst recharges every 2 seconds or every time you go airborne.

PLACE

PLace posts the current position of your rider.

LAP TIMES

Lap Times posts the time of each lap.

LAPS

Laps displays the current lap number of your ride.

RADAR

Radar allows you to view the layout of the track as you race. Use the map to also keep a eye on each race car. You are represented by a red dot on the map. In a 2-player game, the green dot represents player 2.

989 Sports' Tip:

After clearing a jump leading into a corner, you can "steer" in the air to line yourself up on the landing to make a better turn.

NEW LAP RECORD

If you finished the race with a lap record, your name will be posted on this screen. You can save your lap records to the MEMORY CARD.

RACE RESULTS

When a race is completed, race results will be shown with the finishing position and time of all riders.

SEASON STANDINGS

Season standings will be shown at the end of each season race. The standings are based on the total number of points received for each finished race. See *Scoring* for more information on points received for finishing position. Your goal is to finish the season with the highest point total among the racing field.

SAVE DATA

At the end of a season race, you will have the opportunity to save the current season to your MEMORY CARD from the Season menu.

- D-Pad Up/Down to Save Data and press ⊗.
- D-Pad Left/Right to select a block of memory and press ⊗.

If you plan to overwrite a previously saved season:

- D-pad Up/Down to Yes and press ⊗.
- Choose Yes again to overwrite the file.
- When the new season is saved, press ⊗ to continue to the Season menu.

SCORING

In a season competition, the object is to finish the season with the most points. The better the finish, the more points you earn.

First Place	25 points
Second Place	22 points
Third Place	19 points
Fourth Place	16 points
Fifth Place	13 points
Sixth Place	9 points
Seventh Place	5 points
Eighth Place	1 point

FREE RIDE SCORING

Scoring during free ride races is accumulated by the number of tricks you can pull off without wiping out.

989 Sports' Tip:

For the best use of the throttle burst, use while on the face of the jump.



PAUSE MENU

During the course of the race, you can press the START button to pause the action and choose from the following menu items. Note in a 2-player race press the select button while in the pause menu to switch between horizontal and vertical split screen.

RESUME

When you have completed altering the menu options, choose Resume and press ⊗ to resume the race in progress.

SOUND

Change the volume level of the game sound and music.

- D-Pad Up/Down to select an option and then Left/Right to raise/lower the volume level.

OPTIONS

Use Options to turn the game screen options of Vibration, Radar, Lap Times and Place ON/OFF. See *Game Screen* for more information on these options.

- D-Pad Up/Down to select an option and press ⊗ to turn the option ON/OFF.

RESTART

Selecting Restart will bring up the Confirm Restart menu. Select Yes to restart the race or No to continue.

QUIT

Selecting Quit will bring up the Confirm Quit menu. Select Yes to quit the race or No to continue.

SuperCross Circuit Credits

989 Sports

IDOL MINDS

LEAD PROGRAMMER

Phil Weeks

PROGRAMMERS

Phil Collins and Jim Mooney

LEAD ARTIST

Scott Atkins

ARTISTS

Noel Esporo, Chris Hassell, Andy Meier, Craig Neering and Peter Walters

989 Sports

ASSOCIATE PRODUCER

Kolbe Launchbaugh

DIRECTOR, SPORTS PRODUCT DEVELOPMENT

Kelly Ryan

PRESIDENT

Kelly Flock

VICE PRESIDENT, MARKETING

Jeffery Fox

DIRECTOR, SPORTS MARKETING

Craig D. Ostrander

PRODUCT MANAGER

Ed Loonam

DIRECTOR, PR & PROMOTIONS

Helene Sheeler

PR & PROMOTIONS

Kim Bardakian, Shon Damron, Marcelyn Ditter, Marc Franklin, Christy Fritts, Robin Jeffers, Bob Johnson, Kristina Kirk, Elena McCoy, Laura Naviaux, Chris Norton, Chris Sturr and Christa Wittenberg

DIRECTOR, CREATIVE SERVICES

Howard Liebeskind

CREATIVE SERVICES

Vyn Arnold, Dustin Duhne, Kevin Marburg, Micheal Raines and Lee Anne Ramsey

DIRECTOR, LEGAL & BUSINESS AFFAIRS

David Greenspan

LEGAL & BUSINESS AFFAIRS

Seth Steinberg, Mimi Nguyen and Sapphira Ng

SOUND DIRECTOR

Buzz Burrowes

SENIOR SOUND DESIGNER

Rex Baca

ADDITIONAL SOUND DESIGNERS

Brad Aldredge and Nathan Brenholdt

SOUND CAPTURE ATHLETE

Bryan Paquette

MUSIC DIRECTOR

Chuck Doud

MENU & IN GAME MUSIC

Chuck Carr and Matt Furniss

“Circus”

Performed by (hed) pe

Courtesy of Jive Records

Written by M.C.U.D., Wesstyle

Courtesy of Zomba Enterprises Inc./M C U D Music/Wesstyle Music

(Both administered by Zomba Enterprises Inc.) (ASCAP)

“Hit Machine”

Written and Performed by Guttermouth

Courtesy of Nitro Records

“Open Mic”

Written and Performed by Strung Out

Strung Out appear courtesy of Fat Wreck Chords

VIDEO PRODUCTION COORDINATOR

Scott McMahon

VIDEO PRODUCTION

Joe Estus

VIDEO PRODUCTION ARTISTS

Jeff Vargas and Gene Strocchio

DIRECTOR, PRODUCT DEVELOPMENT SERVICE GROUP

Dwayne Mason

DOCUMENTATION AND LAYOUT

David Lovalvo

QUALITY ASSURANCE SUPERVISOR

Chris Caprio

TEST MANAGER

Ritchard Markelz

LEAD ANALYSTS

Doug Damron and Kevin Simmons

TECHNICAL COORDINATORS

Kevin Simmons and Sam Thompson

ANALYSTS

Raymond Basso, Brandon Jones, Adrian Langlois, Jude Liberty, Mark Ranallo, Steve Schulte and Gary Vaolis

RIDER AI CONSULTANTS

Sebastien Tortelli, Mike LaRocco, Mickael Pichon, Ryan Hughes, Damon Huffman, Greg Albertyn, Jeff Emig, Jimmy Button, Timmy Ferry, Larry Ward, Doug Henry, John Dowd, Kevin Windham, Steve Lamson, Casey Johnson and Casey Lytle

SPECIAL THANKS

Allan Frankel, Tim Granich, Troy Mack, Kaz Hirai, Jack Tretton, Frank O'Malley, Brian Dimick, Butch Freedhoff, Brian Hale, George Richard, Riley Russell, Michelle Manahan, Jean Galli, Chris Clark, Ron Eagle, Jeff Hutchinson, Brett Robinson, Rick Rooney, Glenn Nash, Karen Busch, Rick Rossiter, Becky Sanford, Tina Cruz, Kristin Shatouski, Mike LaRocco, Fred Bramblett, Jim Talkington, Pete Clark, Dave Stevenson, Jeff Surwall, Kinney Jones, Davey Coombs, Carrie Coombs, Yamaha of Troy, Primal Impulse, KTM, Rich Winkler, National Promoters Group, Robert Clark, Tracy Rossiter, Fuel RTM Inc., and Butler, Shine & Stern

THE #1 SNOWBOARDING SERIES GOES HUGE!

- Top-notch gameplay features improved physics, Trickmaster Mode and Special events
- Rocket down 30 all new courses on 34 boards from 9 top manufacturers
- Rip a slew of new tricks and combos as one of 16 professional riders
- Customize your own rider, outfit and board

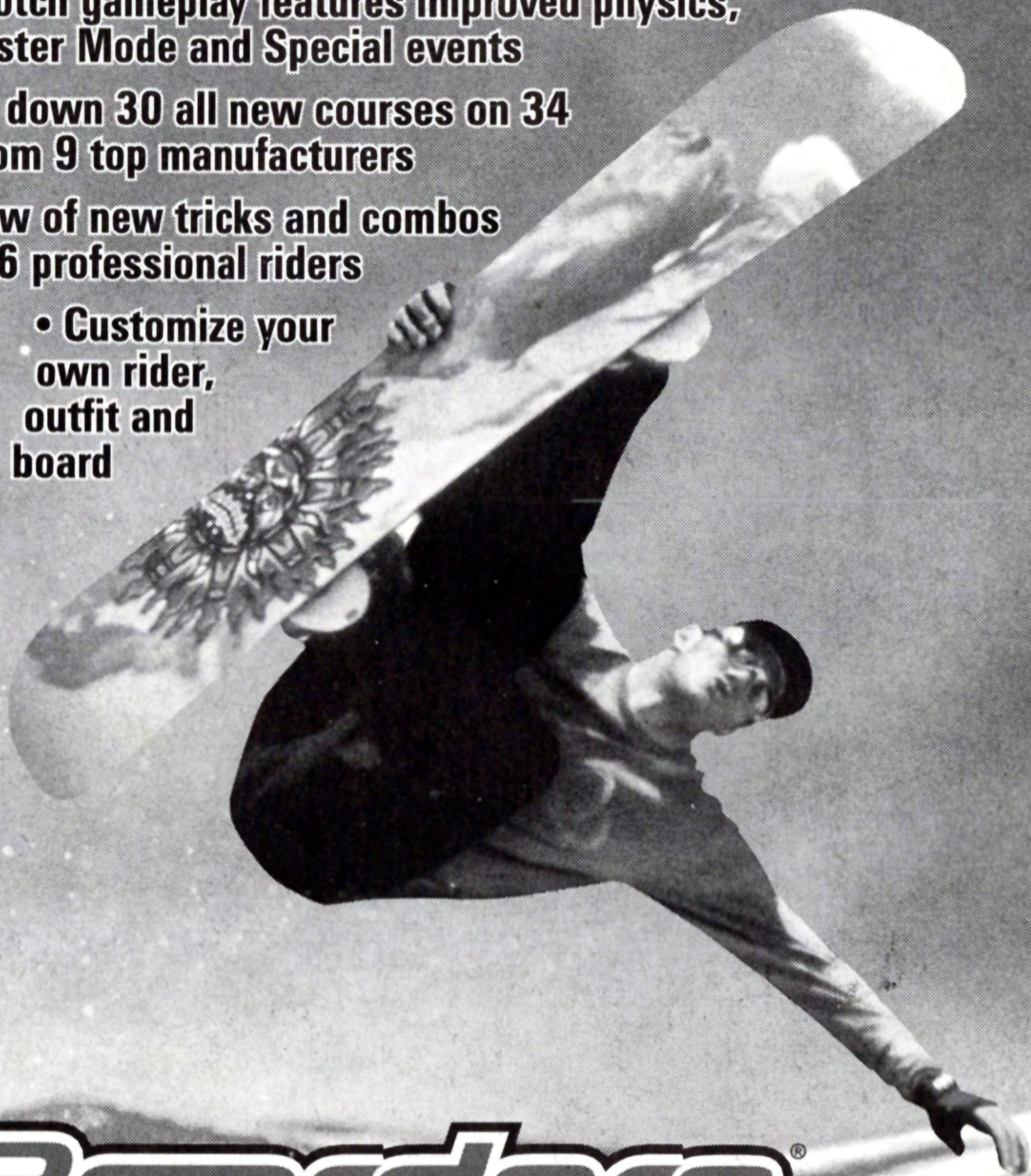

Cool Boarders 4

www.989studios.com



Cool Boarders is a registered trademark and 989 Studios and the 989 Studios logo are trademarks of Sony Computer Entertainment America Inc. Designed and developed by Idol Minds, L.L.C. Published by 989 Studios. © 1999 Sony Computer Entertainment America Inc. PlayStation and the PlayStation logos are registered trademarks of Sony



SOFTWARE WARRANTY

989 Studios warrants to the original purchaser of this product that this Software CD is free from defects in material and workmanship for a period of ninety (90) days from the original date of purchase. 989 Studios agrees for a period of ninety (90) days from the original date of purchase to either repair or replace, at its option, this 989 Studios product. You must call 1-800-345-SONY to receive instructions to obtain repair/replacement services.

This warranty shall not be applicable and shall be void if the defect in the 989 Studios product has arisen through abuse, unreasonable use, improper use, mistreatment, or neglect. THIS WARRANTY IS IN LIEU OF ALL OTHER WARRANTIES AND NO OTHER REPRESENTATIONS OR CLAIMS OF ANY NATURE SHALL BE BINDING ON OR OBLIGATE 989 STUDIOS. ANY IMPLIED WARRANTIES APPLICABLE TO THIS SOFTWARE PRODUCT, INCLUDING WARRANTIES OF MERCHANTABILITY AND FITNESS FOR A PARTICULAR PURPOSE, ARE LIMITED TO THE NINETY (90) DAY PERIOD DESCRIBED ABOVE. IN NO EVENT WILL 989 STUDIOS BE LIABLE FOR INCIDENTAL OR CONSEQUENTIAL DAMAGES RESULTING FROM POSSESSION, USE OR MALFUNCTION OF THE 989 STUDIOS SOFTWARE PRODUCT.

Some states do not allow limitations as to how long an implied warranty lasts and/or exclusions or limitations of consequential damages, so the above limitations and/or exclusions of liability may not apply to you. This warranty gives you specific legal rights, and you may also have other rights which vary from state to state.

"NFL XTREME 2 IS A TOPNOTCH ARCADE-STYLE FOOTBALL GAME."

-GAMEPRO

...BLITZ 2000 OR XTREME 2 ON THE PLAYSTATION, I'D GO WITH XTREME 2."

-GAME INFORMER



PlayStation

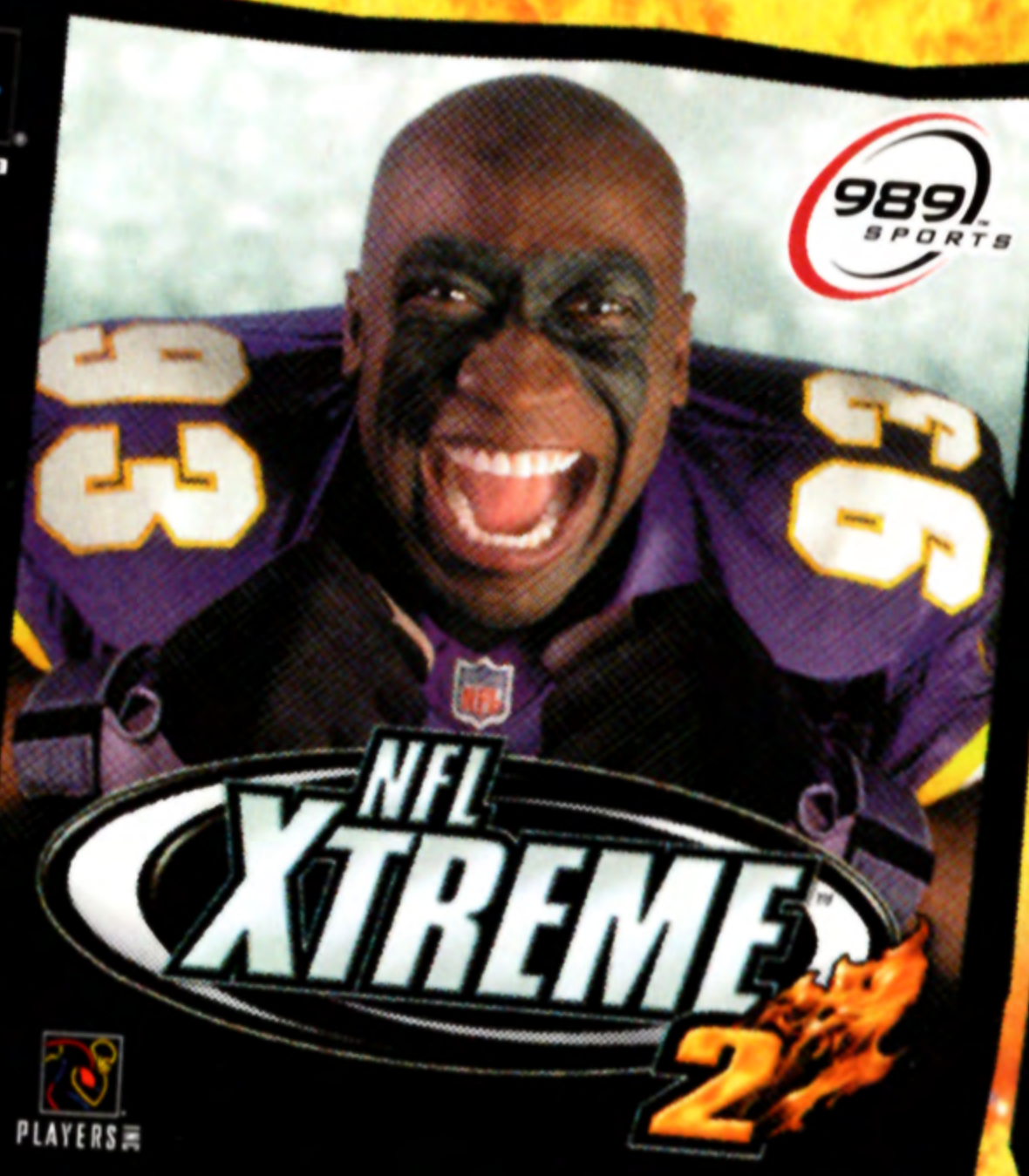

Chandler can't handle Neil Smith



McGlockton can't stop Davis' circus catch



McCaffrey going topless



It's John Randle's world! Only the strong survive

NEW - Big Hits, Trick Plays & No Flags

NEW - Smack Talk from 23 Real NFL Players

NEW - More than 350 Wild Animations

NEW - Lightning Quick Play Selection

NEW - Unbelievably Fast Gameplay

NEW - Humongous players roam the gridiron

www.989sports.com

AVAILABLE NOW!

989 Studios, 989 East Hillsdale Blvd., Foster City, CA 94404

SuperCross Circuit, 989 Sports and the 989 Sports logo are trademarks of Sony Computer Entertainment America Inc. Designed and developed by Idol Minds, LLC. Published by 989 Sports. © 1999 Sony Computer Entertainment America Inc.

© 1999 NFLP. Team names and logos are trademarks of the teams indicated. All other (NFL-related marks) are trademarks of the National Football League and NFL Properties. Officially licensed product of PLAYERS INC. The PLAYERS INC logo is a registered trademark of the NFL Players. www.nflplayers.com. © 1999 PLAYERS INC. 989 Sports and the 989 Sports logo are trademarks of Sony Computer Entertainment America Inc. Developed by 989 Sports. © 1999 Sony Computer Entertainment America Inc.

Licensed for use with the PlayStation game console. PlayStation and the PlayStation logos are registered trademarks of Sony Computer Entertainment Inc. The ratings icon is a trademark of the Interactive Digital Software Association. Manufactured and printed in the U.S.A. THIS SOFTWARE IS COMPATIBLE WITH PLAYSTATION GAME CONSOLES WITH THE NTSC U/C DESIGNATION U.S. AND FOREIGN PATENTS PENDING.



PLAYERS INC